

Illuminated Tactile Switches Series SPDK

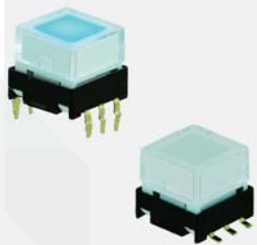

PAT. I 328824
PAT. ZL 2007 2 0141338.4

- Features**
- Bright LEDs of Single, Dual or RGB colors available.
 - Full face illumination.
 - Small and short body for mounting in tight spaces.
 - Snap-acting contact mechanism.
 - Build your own legend.
 - Long operating Life.

General Specifications

Circuit	:SPST
Current Rating	:50mA @ 12VDC
Contact Resistance	:100mOhm Max.(initial)
Insulation Resistance	:100MOhm Min.
Operating Force	:220gf±50gf
Total Travel	:0.3mm±0.1mm
Operating Life	:1,000,000 cycles Min.
Operating Temperature	:-25 deg.~+60 deg.
Solder Specifications	:250 deg

Materials

Cover	:Polycarbonate (PC)
Reflector	:Polyamide(PA10T)
Base	:LCP
Action Dome	:Stainless steel with silver plating
Terminal	:Phosphor bronze (PBS) with gold plating

Contact Configuration

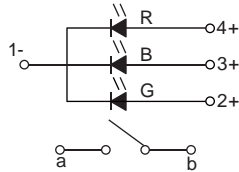

Contact Configuration
Switch with RGB colors LED

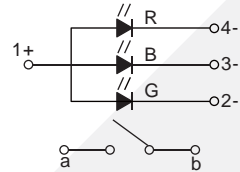

Contact Configuration
Switch with RGB 1 colors LED

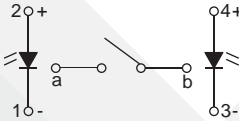

Contact Configuration
Switch with Two colors LED

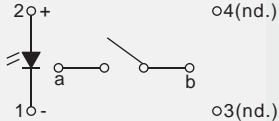

Contact Configuration
Switch with Single color LED

PCB. layout

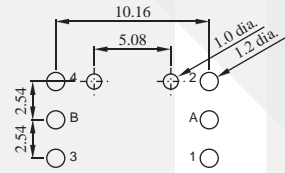

SPDKP

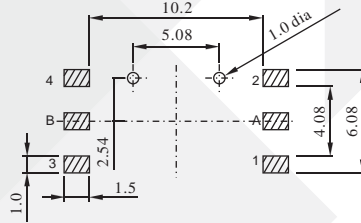

SPDKT

Illuminated Tactile Switches Series SPDK

Dimension of SPDKP

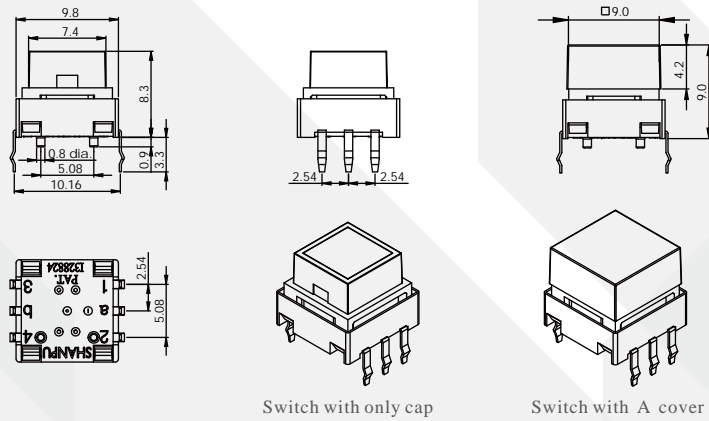

Dimension of SPDKT

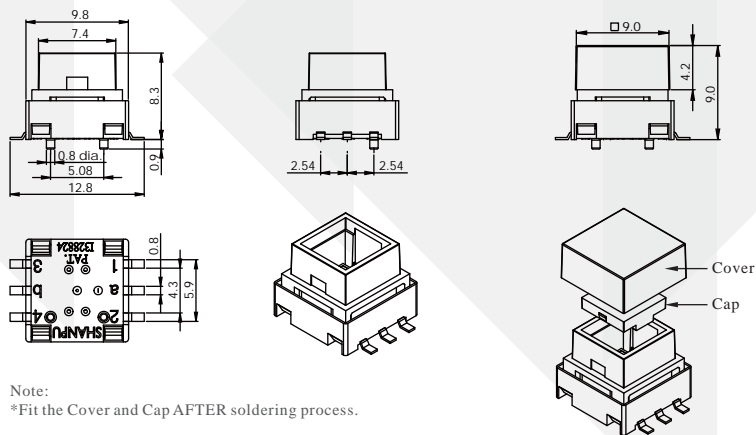

Note:
*Fit the Cover and Cap AFTER soldering process.

Taping reel Dimension

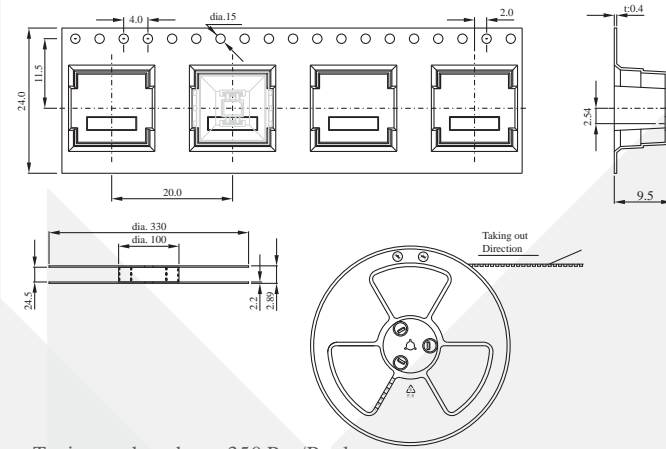

Illuminated Tactile Switches Series SPDK

How to Order

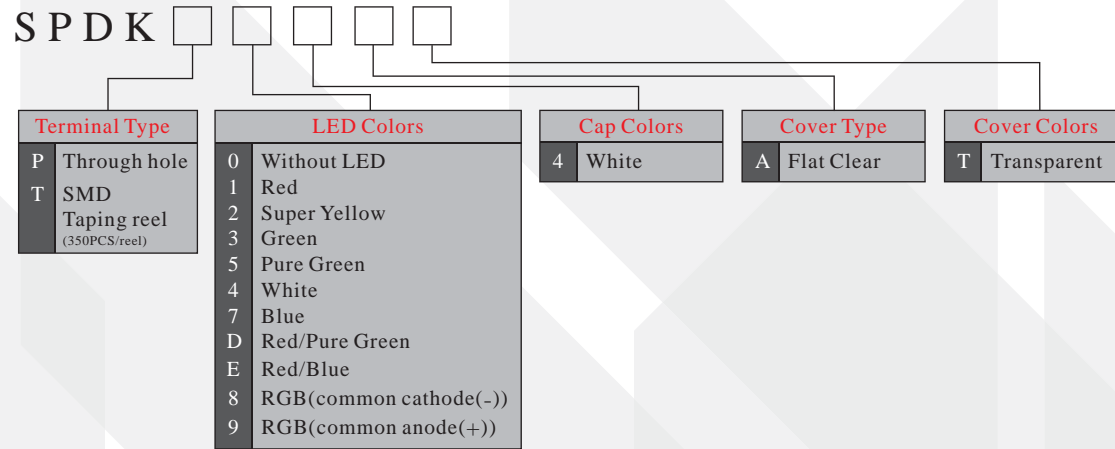

EXAMPLE: SPDKT94AT

Illuminated Tactile Switches Series SPD

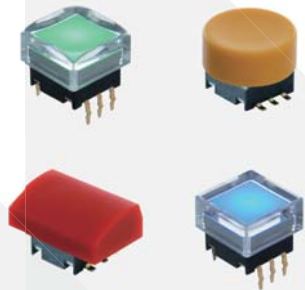

PAT. I 328824
PAT. ZL 2007 2 0141338.4

General Specifications
 Circuit :SPST
 Current Rating :50mA @ 12VDC
 Contact Resistance :100mOhm Max. (initial)
 Insulation Resistance :100MOhm Min.
 Operating Force :220gf±50gf
 Total Travel :0.3mm±0.1mm
 Operating Life :1,000,000 cycles Min.
 Operating Temperature :-10 deg.~+60 deg.
 Solder Specifications :260 deg. for 3 seconds

Materials
 Cover :Polycarbonate (PC)
 Reflector :Polyamide(PA)
 Base :LCP
 Action Dome :Stainless steel with silver plating
 Terminal :Phosphor bronze (PBS) with gold plating

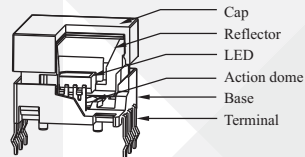

SPD0P

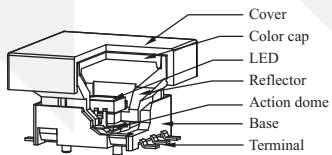

SPD2S

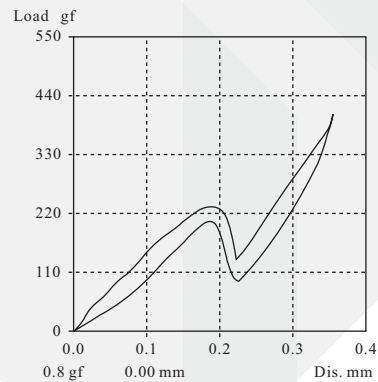

- Features**
- Bright LEDs of Single, Dual or RGB colors available.
 - Full face illumination.
 - Small and short body for mounting in tight spaces.
 - Snap-actioning contact mechanism.
 - Build your own legend.
 - Long operating Life.

Contact configuration

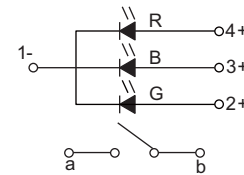

Contact Configuration Switch with RGB colors LED

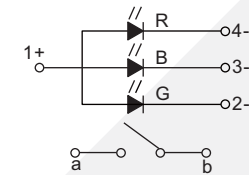

Contact Configuration Switch with RGB1 colors LED

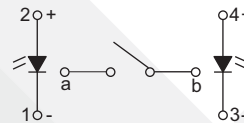

Contact Configuration Switch with Dual colors LED

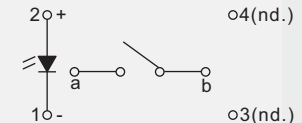

Contact Configuration Switch with Single color LED

PCB. layout

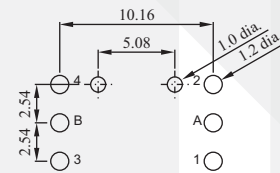

SPD0P
SPD2P

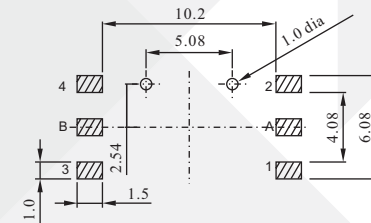

SPD0S
SPD2S

Illuminated Tactile Switches Series SPD

Dimension of SPD0P

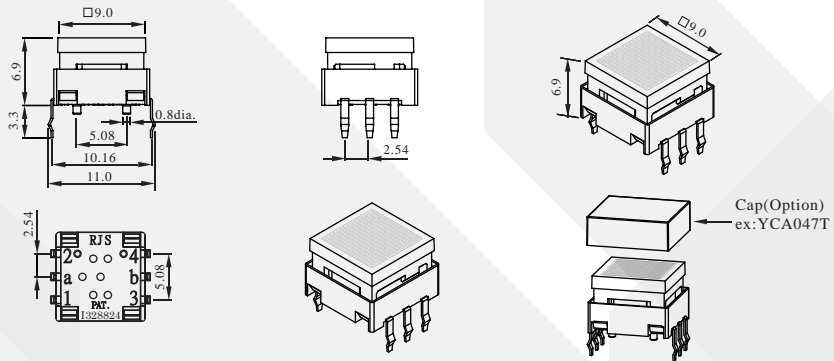

Dimension of SPD2P

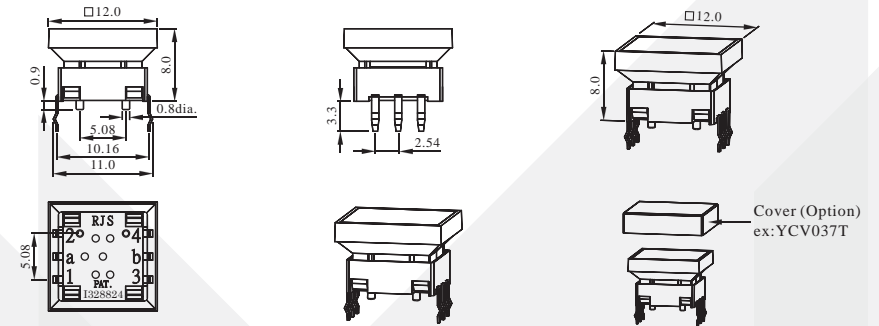

Dimension of SPD0S

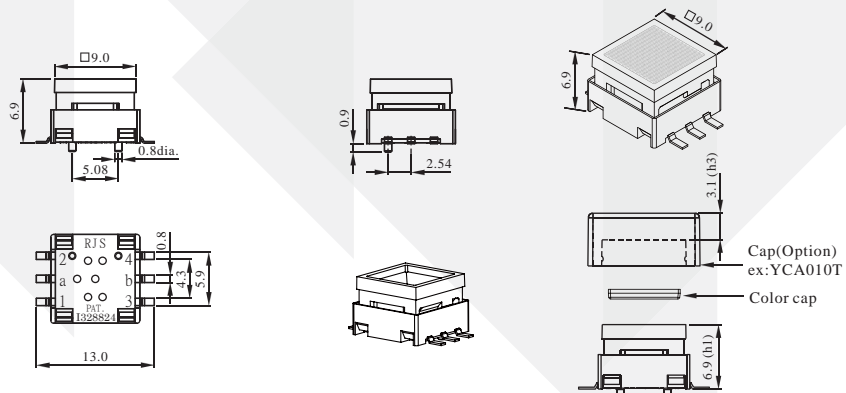

Note:
*Fit the cap and color Cap AFTER soldering process.

$$(h1) 6.9\text{mm} + (h3) 3.1\text{mm} = (h) 10.0\text{mm}$$

Dimension of SPD2S

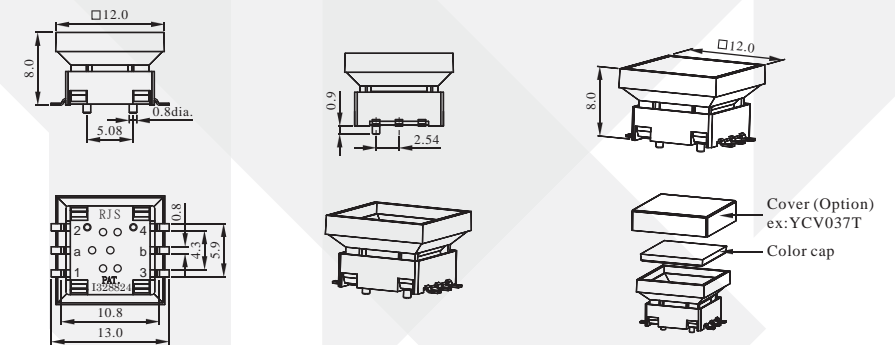

Note:
*Fit the Cover and color Cap AFTER soldering process.

Illuminated Tactile Switches Series SPD

Dimension of SPDGP

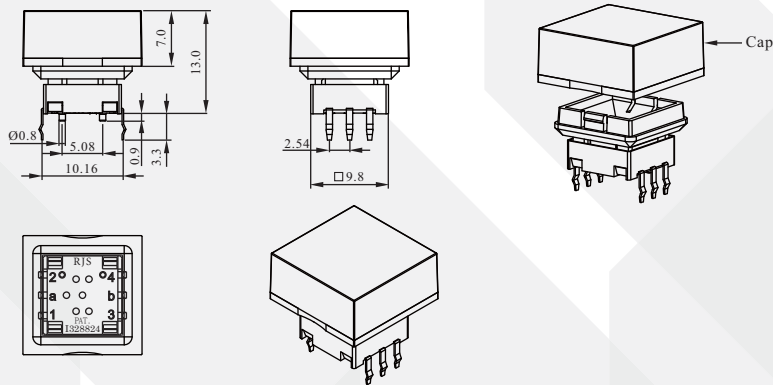

Dimension of SPDGS

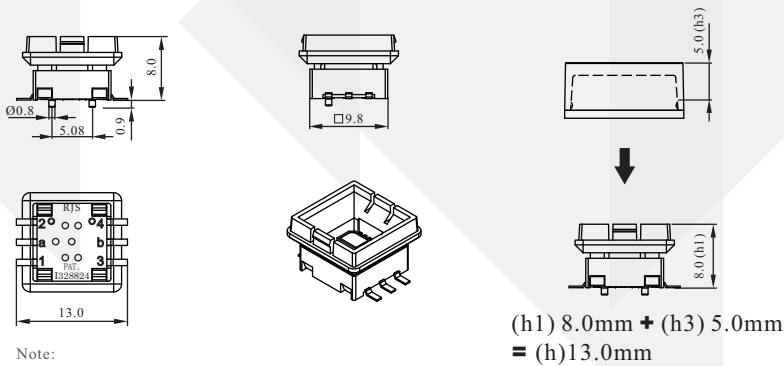

Taping reel Dimension

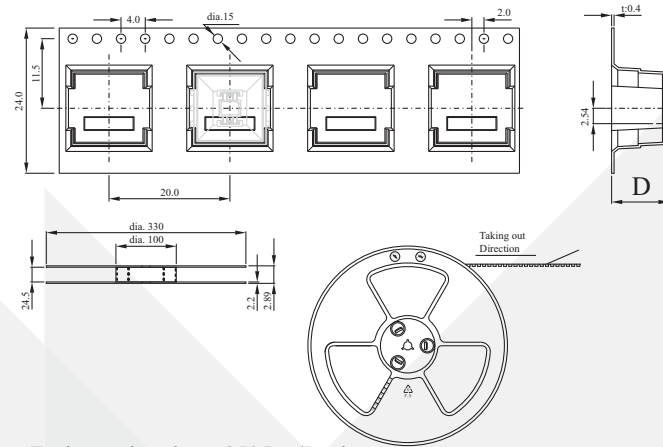

Taping reel package: 350 Pcs/Reel
 D=8.5 for "SPD0T"
 D=9.5 for "SPD2T & SPDGT"

Illuminated Tactile Switches Series SPD

How to Order

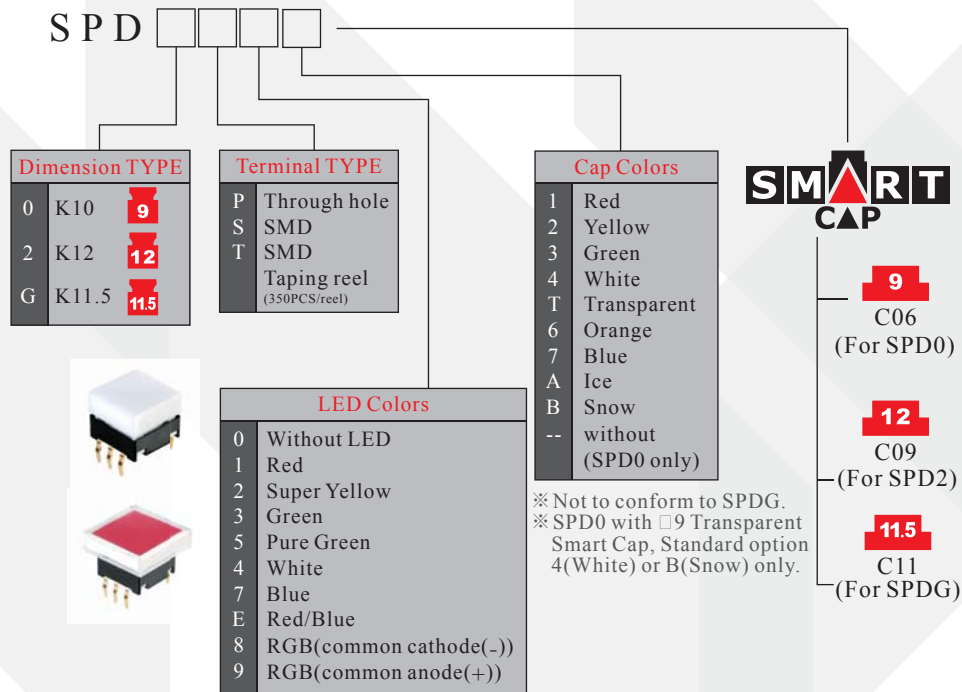







EXAMPLE:

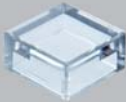

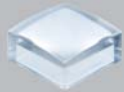
SPD0P24YCA047T

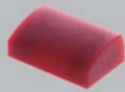
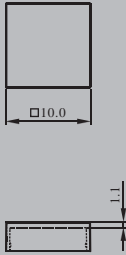
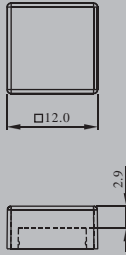
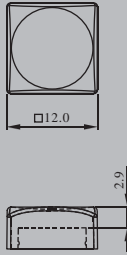
From Page C06

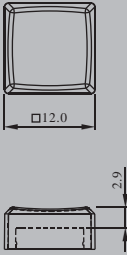
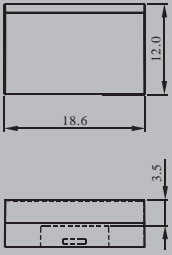



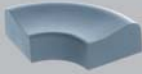

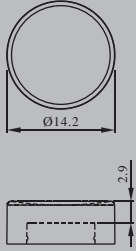
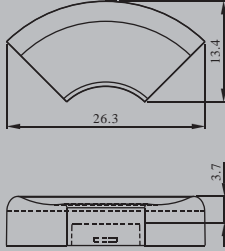
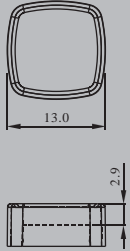



□ 9 SMART cap option

Shape						
Dimension						
Transparent with Diffuser	YCA047TD	YCA010TD	YCA011TD	YCA012TD	YCA013TD	—
Transparent	YCA047T	YCA010T	YCA011T	YCA012T	YCA013T	—
Ice	—	—	—	—	—	—
Snow	—	—	—	—	—	YCA016B
Transparent Black	—	—	—	—	—	—
Red	—	—	—	—	—	YCA0161
Yellow	—	—	—	—	—	YCA0162
Green	—	—	—	—	—	YCA0163
White	YCA0474	YCA0104	YCA0114	YCA0124	YCA0134	YCA0164
Black	—	—	—	—	—	YCA0165
Orange	—	—	—	—	—	YCA0166
Blue	—	—	—	—	—	YCA0167
Grey	—	—	—	—	—	YCA0169
SPD0 (h)	8.0mm	9.8mm	9.8mm	9.8mm	9.8mm	10.4mm
ZSPE9 (h)	13.1mm	14.9mm	14.9mm	14.9mm	14.9mm	15.5mm



□ 9 SMART cap option

Shape						
Dimension						
Transparent with Diffuser	—	—	—			
Transparent	—	—	—			
Ice	—	—	—			
Snow	YCA017B	YCA018B	YCA019B			
Transparent Black	—	—	—			
Red	YCA0171	YCA0181	YCA0191			
Yellow	YCA0172	YCA0182	YCA0192			
Green	YCA0173	YCA0183	YCA0193			
White	YCA0174	YCA0184	YCA0194			
Black	YCA0175	YCA0185	YCA0195			
Orange	YCA0176	YCA0186	YCA0196			
Blue	YCA0177	YCA0187	YCA0197			
Grey	YCA0179	YCA0189	YCA0199			
SPD0 (h)	9.8mm	10.6mm	9.8mm			
ZSPE9 (h)	14.9mm	15.7mm	14.9mm			

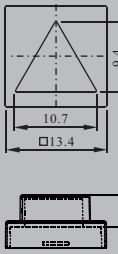



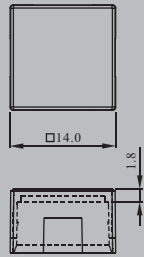
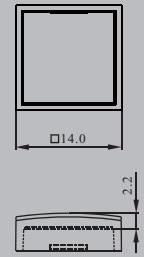

□ 12 SMART cap option

Shape						
Dimension						
Transparent	YCV037T	YCV038T	YCV039T	YCV040T	YCV041T	YCV042T
Ice	—	—	—	—	—	—
Snow	—	—	—	—	—	—
Transparent Black	—	—	—	—	—	—
Red	—	—	—	—	—	—
Yellow	—	—	—	—	—	—
Green	—	—	—	—	—	—
White	—	—	—	—	—	—
Orange	—	—	—	—	—	—
Blue	—	—	—	—	—	—
SPD2 (h)	8.8mm	10.2mm	12.2mm	10.2mm	12.2mm	12.2mm



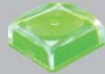



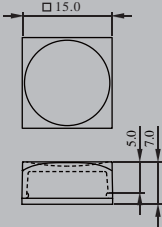
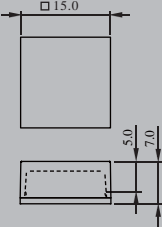
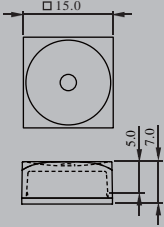
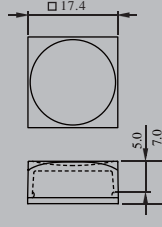
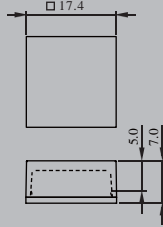
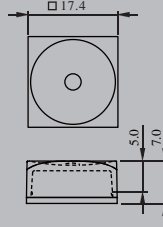

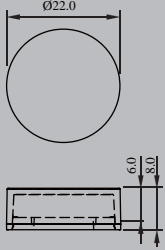

□ 12 SMART cap option

Shape						
Dimension						
Transparent	YCV043T	YCV044T				
Ice	—	—				
Snow	—	—				
Transparent Black	—	—				
Red	—	—				
Yellow	—	—				
Green	—	—				
White	YCV0434	YCV0444				
Orange	—	—				
Blue	—	—				
SPD2 (h)	9.8mm	10.2mm				

□ 11.5 SMART cap option

Shape						
Dimension						
Transparent	—	—	—	—	—	—
Ice	YCS004A	YCS005A	YCS006A	YCS001A	YCS002A	YCS003A
Snow	YCS004B	YCS005B	YCS006B	YCS001B	YCS002B	YCS003B
Transparent Black	—	—	—	—	—	—
Red	YCS0041	YCS0051	YCS0061	YCS0011	YCS0021	YCS0031
Yellow	YCS0042	YCS0052	YCS0062	YCS0012	YCS0022	YCS0032
Green	YCS0043	YCS0053	YCS0063	YCS0013	YCS0023	YCS0033
White	YCS0044	YCS0054	YCS0064	YCS0014	YCS0024	YCS0034
Orange	YCS0046	YCS0056	YCS0066	YCS0016	YCS0026	YCS0036
Blue	YCS0047	YCS0057	YCS0067	YCS0017	YCS0027	YCS0037
SPDG (h)	13.0mm	13.0mm	13.0mm	13.0mm	13.0mm	13.0mm
SPCG (h)	19.5mm	19.5mm	19.5mm	19.5mm	19.5mm	19.5mm

□ 11.5 SMART cap option

Shape						
Dimension						
Transparent		—				
Ice		—				
Snow		—				
Transparent Black		—				
Red		—				
Yellow		—				
Green		—				
White		YCS0284				
Orange		—				
Blue		—				
SPDG (h)		14.0mm				
SPCG (h)		20.5mm				